

MAGICFX[®] SUPER BLASTER XL

PRODUCTCODE : MFX0802
VERSION : 1.0
DATE : 03.06.2012



1. CONGRATULATIONS!

You have purchased a Super Blaster XL, a great and innovative product from MAGICFX®.

MAGIC FX is a Dutch manufacturer of professional special effects machinery and equipment. We have specialized in special effects since we established our business in 1995. All products are manufactured under the brand name MAGICFX®, which has acquired an excellent reputation for quality and reliability. All products are manufactured in accordance with the European Machinery Directive. MAGIC FX handles the entire production in-house from concept to finished product. We take care of the design, prototyping and manufacturing process.



MAGICFX® products are used by special effects professionals around the world and distributed by a dealer network across more than 80 countries.

You can rely on MAGICFX® for excellent effects!
We work hard to keep you, our customer, satisfied.

Congratulations and a lot of success and amazing shows with your new MAGICFX® Super Blaster XL!

MAGICFX®

2. CE MARKING

	<p>NOTE: We must assume that you, your employees and others who use or come into contact with the machine are familiar with how the machine should be utilized. This specifically pertains to the proper use, maintenance and repair of the machine as described in this user manual. This also means that employees should be qualified to use machinery through training or experience. It is required that the user of this product has followed a training for the correct use of this product. Trainings are provided by MAGIC FX.</p>
	<p>DANGER WARNING: The Super Blaster XL must only be used according to the prescriptions and instructions in this manual. Consult MAGIC FX if there are any doubts about usage.</p>

Disclaimers:

MAGIC FX B. V. specifically disclaims liability for unsafe situations, accidents and damages caused by:

- Ignoring warnings or prescriptions displayed on the Super Blaster XL or in this documentation.
- Using the equipment for other purposes or situations than specified in this documentation.
- Modifications to the Super Blaster XL. This includes the use of non-original spare parts.
- Improper maintenance.
- Unauthorized removal of safety covers and/or safety devices.
- Improper use of the machine.

MAGIC FX B.V. is not liable for any damages due to failures of the Super Blaster XL.

© Copyright 2012

All rights reserved. No part of this manual may be reproduced, stored in a retrieval system or transmitted in any form or by any means, electronic, mechanical, photocopied, recorded or otherwise without the prior written permission of MAGIC FX B.V.

MAGIC FX reserves the right to make modifications at any time without having to notify the customer beforehand. The content of this manual may also be modified.

For additional information about maintenance, repair, and so on, please contact your supplier's technical department. This manual was written with the utmost care. MAGIC FX cannot be held liable for errors contained in this document or consequences thereof.

3. DECLARATION OF CONFORMITY

DECLARATION OF CONFORMITY
(according to Annex IIA of the Machinery Directive)



With respect to the Machinery Directive.
MAGIC FX B.V.
Industrieweg 16
5281 RW Boxtel
The Netherlands

Hereby declares under our sole responsibility:
We are the manufacturer of the product:

MFX0802 - MAGICFX® Super Blaster XL

to which this declaration pertains and it is in conformity with the provisions of the following guidelines:

- Pressure Equipment Directive 97/23/EC

City: Boxtel
Date : 08-06-2010

Name: MAGIC FX

A handwritten signature in black ink, appearing to be 'B. Veroude', is written over a horizontal line. The signature is stylized and includes a large circular flourish on the left side.

Director: B. Veroude

4. FOREWORD

This manual provides pertinent information about the MAGICFX® Super Blaster XL. The information in this manual is important with respect to the proper and safe operation of the Super Blaster XL. If you are not familiar with the installation, operation, preventive maintenance, etc., of the Super Blaster XL then read this manual in its entirety. MAGIC FX also urges all new users (operators, installers, maintenance staff and possibly cleaning staff) to receive training on the equipment using this manual as the basis for the training.

MAGIC FX recommends you keep the original of this manual and its attachments in a secure central location, and, keep another copy of this manual close to the workplace where the Super Blaster XL will be used.

If you are well acquainted with the proper handling of the equipment then keep this manual handy for reference.

The following conventions are used in this manual to draw your attention to specific information or actions.





	<p>TIP: This provides you with suggestions and advice on how to perform tasks in an easier or more convenient way.</p>
	<p>NOTE: This is a note providing supplemental information that alerts you to possible problems.</p>
	<p>CAUTION: This indicates that the equipment may be damaged if procedures are not carried out in the proper manner.</p>
	<p>DANGER WARNING: This indicates that you may cause yourself injury, possibly serious, if procedures are not carried out in the proper manner.</p>

TABLE OF CONTENTS

1.	CONGRATULATIONS!	1
2.	CE MARKING.....	2
3.	DECLARATION OF CONFORMITY.....	3
4.	FOREWORD	4
5.	INTRODUCTION	6
5.1	DESCRIPTION OF THE SUPER BLASTER XL AND ITS USAGE	6
5.2	NECESSARY ACCESSORIES.....	6
6.	SAFETY	7
6.1	INTRODUCTION	7
6.2	GENERAL SAFETY RULES.....	7
6.3	WARNINGS.....	7
7.	PARTS	8
8.	ACCESSORIES.....	9
9.	PREPARATION FOR USE.....	9
10.	INSTALLING	10
11.	USAGE	12
12.	TURNING OFF	13
13.	TROUBLESHOOTING	15
14.	TECHNICAL SPECIFICATIONS.....	15
15.	MAINTENANCE	15
16.	GUARANTEE	15

5. INTRODUCTION

5.1 DESCRIPTION OF THE SUPER BLASTER XL AND ITS USAGE

The Super Blaster is designed to project confetti into the sky to create a special effect (of slowly falling confetti) at a sports event, a concert or a festival.

Should you use the Super Blaster in any way other than just described then you release your supplier from all liability.

5.2 NECESSARY ACCESSORIES

The following parts are required with the Super Blaster XL:

		
<p>Manual</p>	<p>CO₂ BOTTLE</p>	<p>CONFETTI</p>

Table 5.1

6. SAFETY

6.1 INTRODUCTION

The Super Blaster XL should be located and used in an environment that preferably:

- Has a fairly constant temperature between 0 and 30°C.
- Has a relative humidity not exceeding a maximum of 75%.
- Is reasonably free of dust, corrosive gases, and high concentrations of organic vapors.
- Does not contain any source of vibrations in the environment.

The Super Blaster XL is designed and constructed so that it can be used in a safe manner. Specifically, this refers to the usage, situations, and prescriptions for the device as described in this documentation. It is the responsibility of all persons authorized to use the Super Blaster XL to read and follow the instructions in this manual.

6.2 GENERAL SAFETY RULES

- Ensure that the Super Blaster XL is not accessible to children, unauthorized persons, or animals!
- Do not touch the Super Blaster XL when it is operational or turned on. Even if the device is not in operation it might be ready to activate.
- Safety devices must not be removed or rendered inoperative.
- All required safety devices should be in good working order and functioning properly.
- Ensure that there is adequate lighting in the environment.
- Keep the workplace clean.
- Only authorized persons may work with the Super Blaster XL.

6.3 WARNINGS

There are several warnings displayed on the Super Blaster XL to which the following restrictions apply:

- The text must not be removed or otherwise spoiled. The operator should regularly check that the warnings are in good condition.
- The operator must ensure that the text is always visible and legible and that it remains so.

	<p>DANGER WARNING: Any missing, damaged, or illegible text or icons must be replaced.</p>
---	--

The icons used are shown below:

Icon	Explanation
 <p>PIC 616 Observe directions for use</p>	<p>Make the operator aware that they may only use the device after they have read the user manual.</p> <p>This warning is indicated with this instruction icon.</p>

7. PARTS

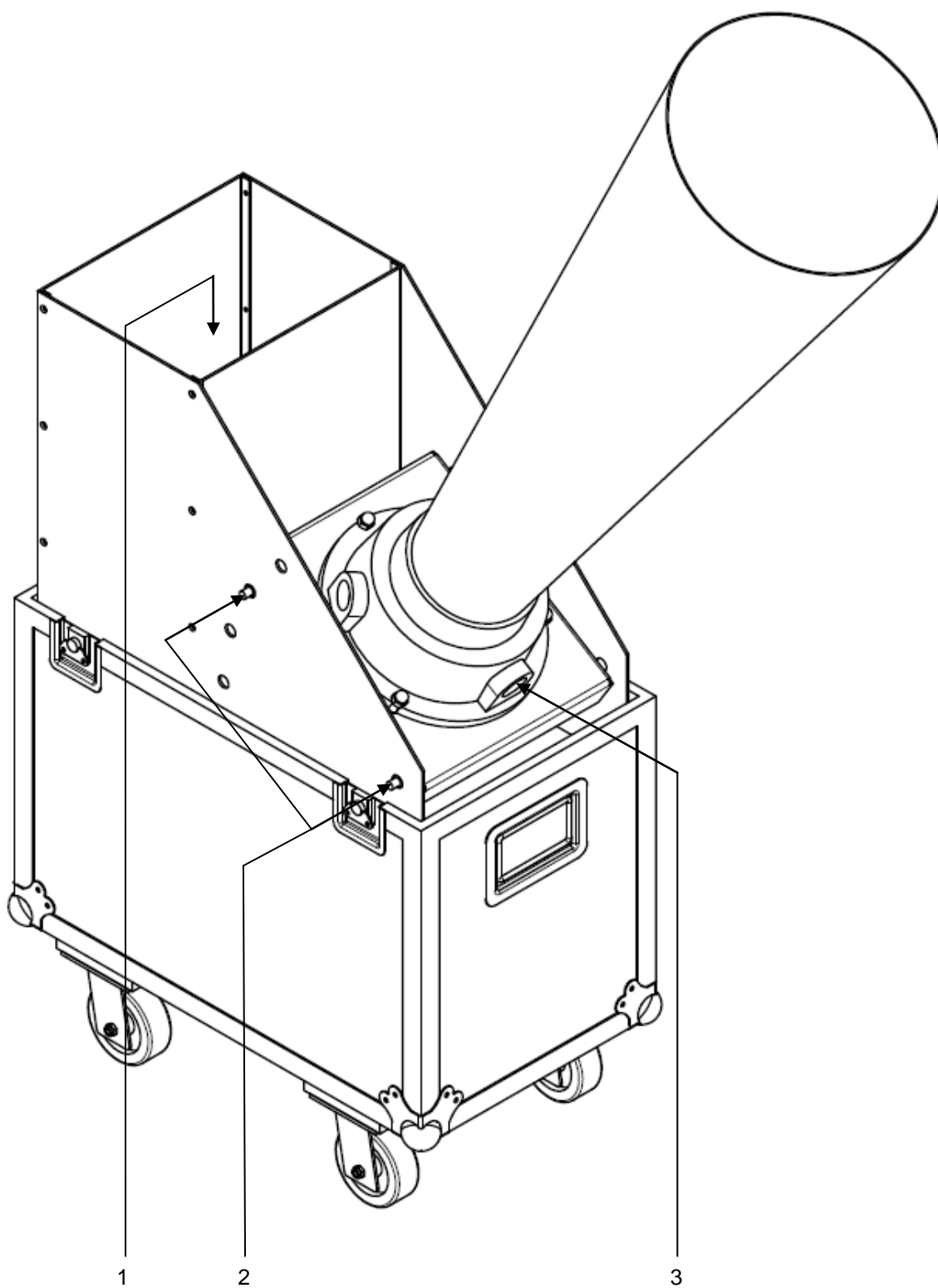

1. Input (confetti reservoir)
2. Aluminium pins
3. CO2 input

8. ACCESSORIES



Table 8.1

You can order the above parts from:



MAGIC FX B.V. Industrieweg 16 NL-5281 RW BOXTEL The Netherlands T. +31(0)411 63 50 13 F. +31(0)411 63 50 12 W. http://www.magicfx.eu E. info@magicfx.eu	
---	--

9. PREPARATION FOR USE

Unpack the Super Blaster XL. Dispose of packaging material without causing harm to the environment.

Check the device for any possible damage. You must report any damage to the device to MAGIX FX.

10. INSTALLING

	<p>CAUTION: This indicates that the equipment may be damaged if procedures are not carried out in the proper manner.</p>
	<p>DANGER WARNING: The MAGICFX® Super Blaster XL may only be installed by authorized adults.</p>

Prepare the Super Blaster XL for use as follows:

1.

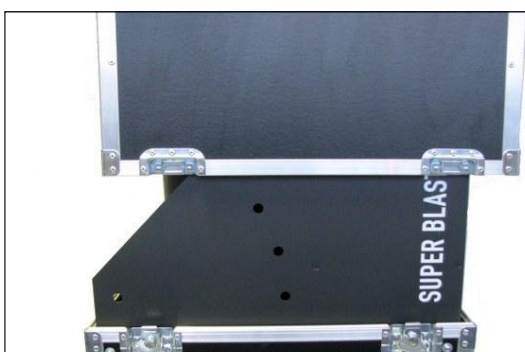

Open the flightcase and by removing the cover.

Take the high pressure hose, the 2 aluminium pins + linchpins and the wrench out of the case.

2.

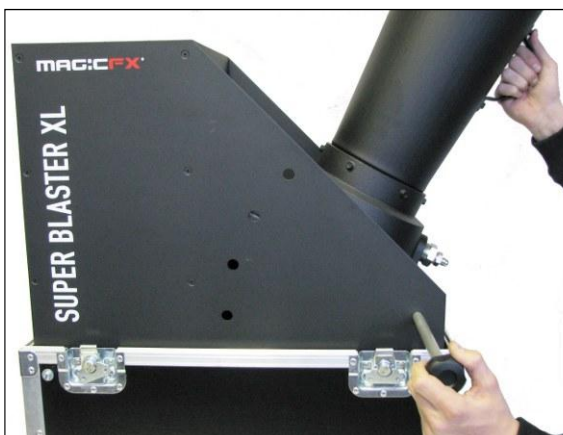

Place the horn in the desired position and connect it by the aluminium pins and secure them with the linchpins.

3.



Connect the CO2 hose to the woofer by using the wrench.

(make sure the ball valve is closed like on the picture left)

4.



Connect the other side of the high pressure hose to a CO2 bottle (liquid CO2 with a dip-pipe).



Connect the special adapter by hand and tighten securely.

5.



Open the CO2 Bottle.

11. USAGE

	<p>TIP: This provides you with suggestions and advice on how to perform tasks in an easier or more convenient way.</p>
	<p>CAUTION: This indicates that the equipment may be damaged if procedures are not carried out in the proper manner.</p>
	<p>DANGER WARNING: The MAGICFX® Super Blaster XL may only be operated by authorized adults.</p> <p>The Super Blaster XL may only be operated if all parts are entire and in good working order and properly connected/installed.</p>

Operate the Super Blaster XL as follows:

1.



Throw 1 hand full with confetti in the machine.

3.



To activate the Super Blaster, open the ball valve.
The machine will start blowing out confetti.

Now immediately start feeding more confetti into the reservoir.

When all the confetti is gone, or when you like to stop the effect, close the ball valve again.

12. TURNING OFF

Turn off the Super Blaster XL as follows:

1.



Close the CO2 bottle.

2.



Open the ball valve once again to make sure there will be no more pressure left inside the hose.

3.

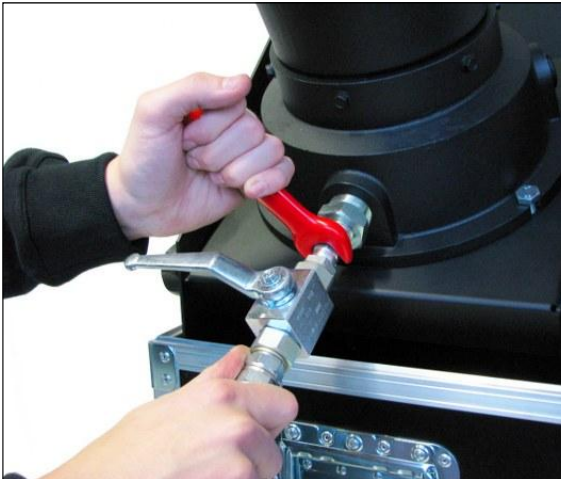

Remove the hose from the horn.

4.

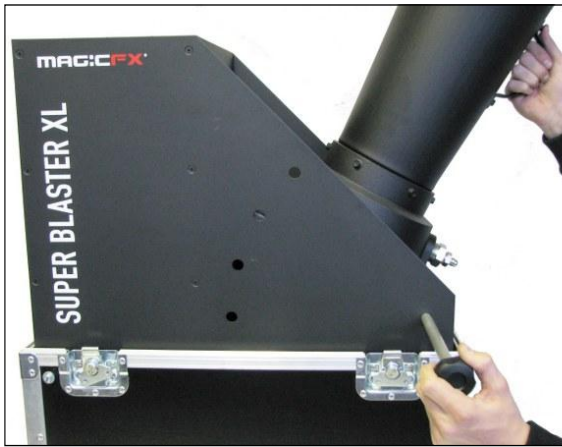

Take the aluminium pins out and place the horn back into the case.

Place the aluminium pins including the linchpins, the wrench and the hose back inside the case.

5.



Take the cover and close the flightcase again.

13. TROUBLESHOOTING

- The Super Blaster is leaking gas.

Check if the hose is connected tight enough to the horn. Try to fasten it more tightly by using a wrench to stop the leaking.

- The CO2 bottle is leaking gas.

Check if the manual adapter is connected well to the CO2 bottle. Use a wrench to connect it more tightly to stop the leaking. If this doesn't solve the problem, close the CO2 bottle, make sure all gas is removed out of the hose by activating the Super Blaster. Now disconnect the manual adapter from the CO2 bottle and check if the rubber sealing ring is still there and if it is not damaged. Replacing the sealing ring will stop the leakage.

- The Super Blaster XL still does not work after troubleshooting

Always contact your dealer or the MAGIC FX technical department if you have any doubts or questions about the operation of or other issues related to the Super Blaster XL.

14. TECHNICAL SPECIFICATIONS

Dimensions and weight	Length:	660mm (26")
	Width:	380mm (14.96")
	Height:	1350mm (53.14")
	Weight:	50kgs (110lbs.)
CO ₂	Input:	Liquid CO ₂
	Output:	CO ₂ Gas
	Consumption:	0,5 Kg/s (1.1 lbs/s)

15. MAINTENANCE

To prolong the life of the Super Blaster XL for as long as possible, you must regularly clean it and test that it functions properly.

Regardless of the reason, contact MAGIC FX if the Super Blaster XL does not work properly



DANGER WARNING:
Never replace parts yourself. Always consult MAGIC FX when needed.

16. GUARANTEE

The MAGIC FX Super Blaster XL has a 3 year factory guarantee.

- The guarantee is annulled should the Super Blaster XL be used for purposes other than intended or for applications that are not listed in the manual.
- The guarantee is annulled should the device be used incorrectly or in a manner contrary to its instructions.
- The guarantee is annulled if the device is altered without the permission of its supplier.